

For reliable performance, the Delta-V™ weld-on shroud LHD lip system is an excellent choice



The Delta-V™ advantage

- Longer wear life as compared to a conventional plate lip
- Available in multiple profiles and spade configurations
- The slim shroud profile has excellent penetration
- Wear material located where it is needed most for a longer service life

Delta-V™ LHD lip system

ESCO’s weld-on shroud LHD lip system is an excellent alternative to mechanically attached configurations. The system reduces inventory by utilizing interchangeable intermediate shrouds and is suitable for back-blading applications. The system is available in multiple lip thicknesses and can be configured to any lip width.

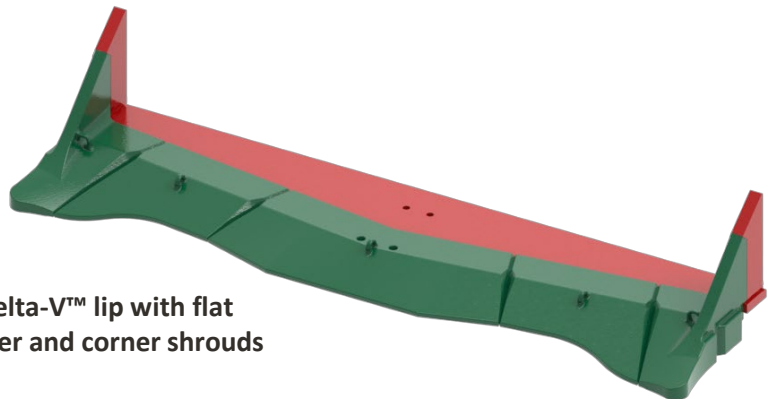

Delta-V™ lip with flat center and corner shrouds

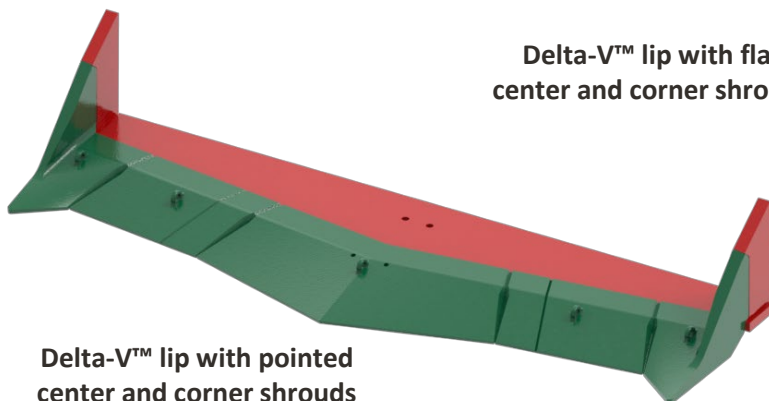

Delta-V™ lip with pointed center and corner shrouds

See next page for the standard offering specifications

ESCO® Delta-V™ weld-on shroud LHD lip system



Pointed center shroud



Flat center shroud

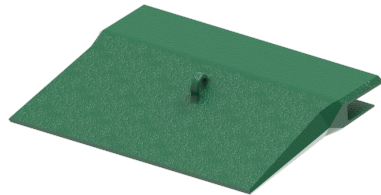
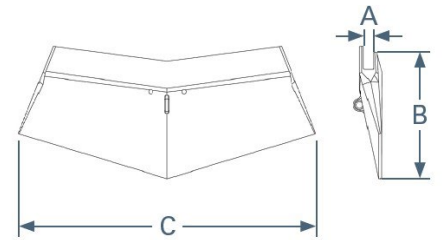

Intermediate shroud

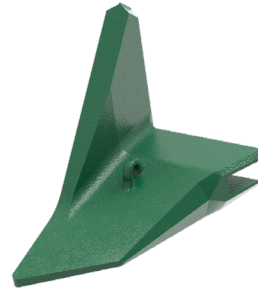
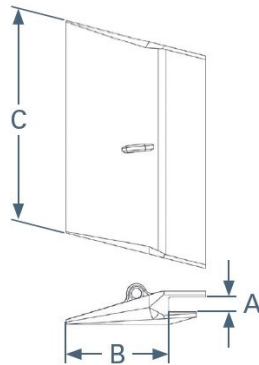

Corner shroud

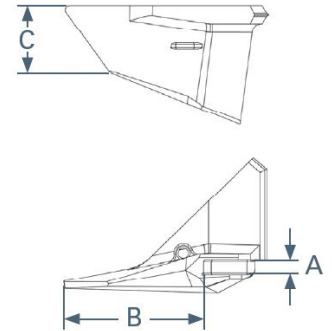

Delta-V™ Weld-on Shrouds for LHD Plate Lips

PMID	Description	Lip Thickness		Extension From Lip		Shroud Width		Weight	
		mm	in	mm	in	mm	in	kg	lb
PDE53765	Pointed Center	25	1.00	253	9.97	786	30.96	49	108
PDE53766-1L	Left-Hand Intermediate	25	1.00	185	7.27	518	20.39	32	71
PDE53766-1R	Right-Hand Intermediate	25	1.00	185	7.27	518	20.39	32	71
PDE53767-1L	Left-Hand Corner	25	1.00	284	11.19	126	4.98	23	50
PDE43767-1R	Right-Hand Corner	25	1.00	284	11.19	126	4.98	23	50
PDE51786	Pointed Center	38	1.50	389	15.32	1249	49.18	168	370
PDE51787-1L	Left-Hand Intermediate	38	1.50	280	11.02	562	22.13	78	171
PDE51787-1R	Right-Hand Intermediate	38	1.50	280	11.02	562	22.13	78	171
PDE51788-1L	Left-Hand Corner	38	1.50	426	16.76	183	7.20	74	163
PDE51788-1R	Right-Hand Corner	38	1.50	426	16.76	183	7.20	74	163
DV4-CTR-P	Pointed Center	38	1.50	385	15.16	1250	49.21	212	468
DV4-CTR-F	Flat Center	38	1.50	285	11.22	1250	49.21	199	438
DV4-INT-580L	Left-Hand Intermediate	38	1.50	418	16.46	711	27.99	104	230
DV4-INT-580R	Right-Hand Intermediate	38	1.50	418	16.46	711	27.99	104	230
DV4-INT-671L	Left-Hand Intermediate	38	1.50	418	16.46	802	31.57	120	264
DV4-INT-671R	Right-Hand Intermediate	38	1.50	418	16.46	802	31.57	120	264
DV4-INT-882L	Left-Hand Intermediate	38	1.50	417	16.42	1013	39.88	155	342
DV4-INT-882R	Right-Hand Intermediate	38	1.50	417	16.42	1013	39.88	155	342
DV4-CNR-L	Left-Hand Corner	38	1.50	461	18.15	196	7.72	123	271
DV4-CNR-R	Right-Hand Corner	38	1.50	461	18.15	196	7.72	123	271

Contact your ESCO representative for additional information or to place an order